



Gipuzkoako Ur Kontsortzioa
Gipuzkoako Urak

PLANOS

RENOVACIÓN SANEAMIENTO COLECTOR POLIGONO KATATEGI Nº12

IRURA



IRURA

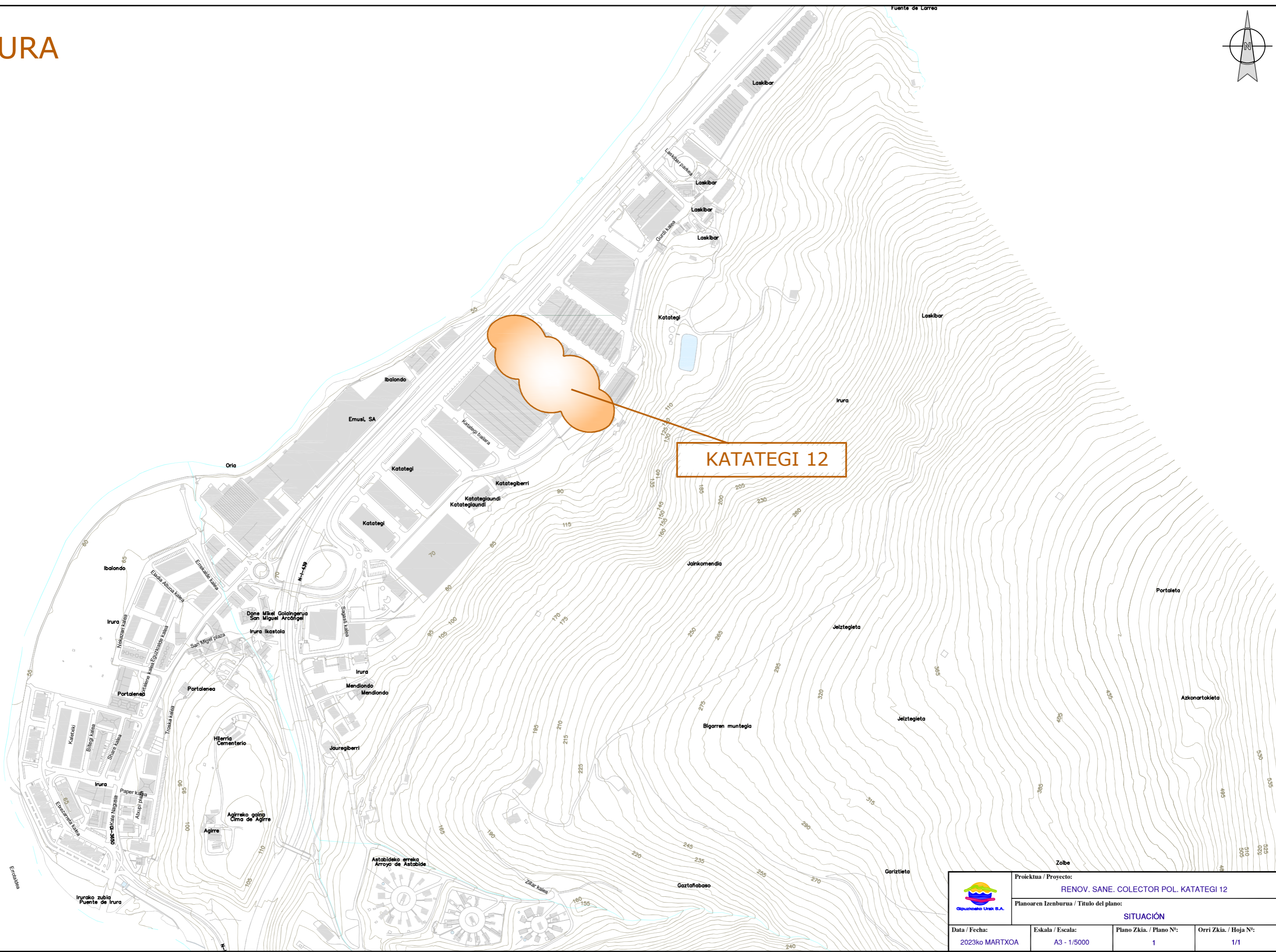
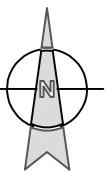

KATATEGI 12

	Proiektua / Proyecto: RENOV. SANE. COLECTOR POL. KATATEGI 12		
	Planoaren Izenburua / Título del plano: SITUACIÓN		
Data / Fecha: 2023ko MARTXOA	Eskala / Escala: A3 - 1/5000	Plano Zkia. / Plano Nº: 1	Orri Zkia. / Hoja Nº: 1/1

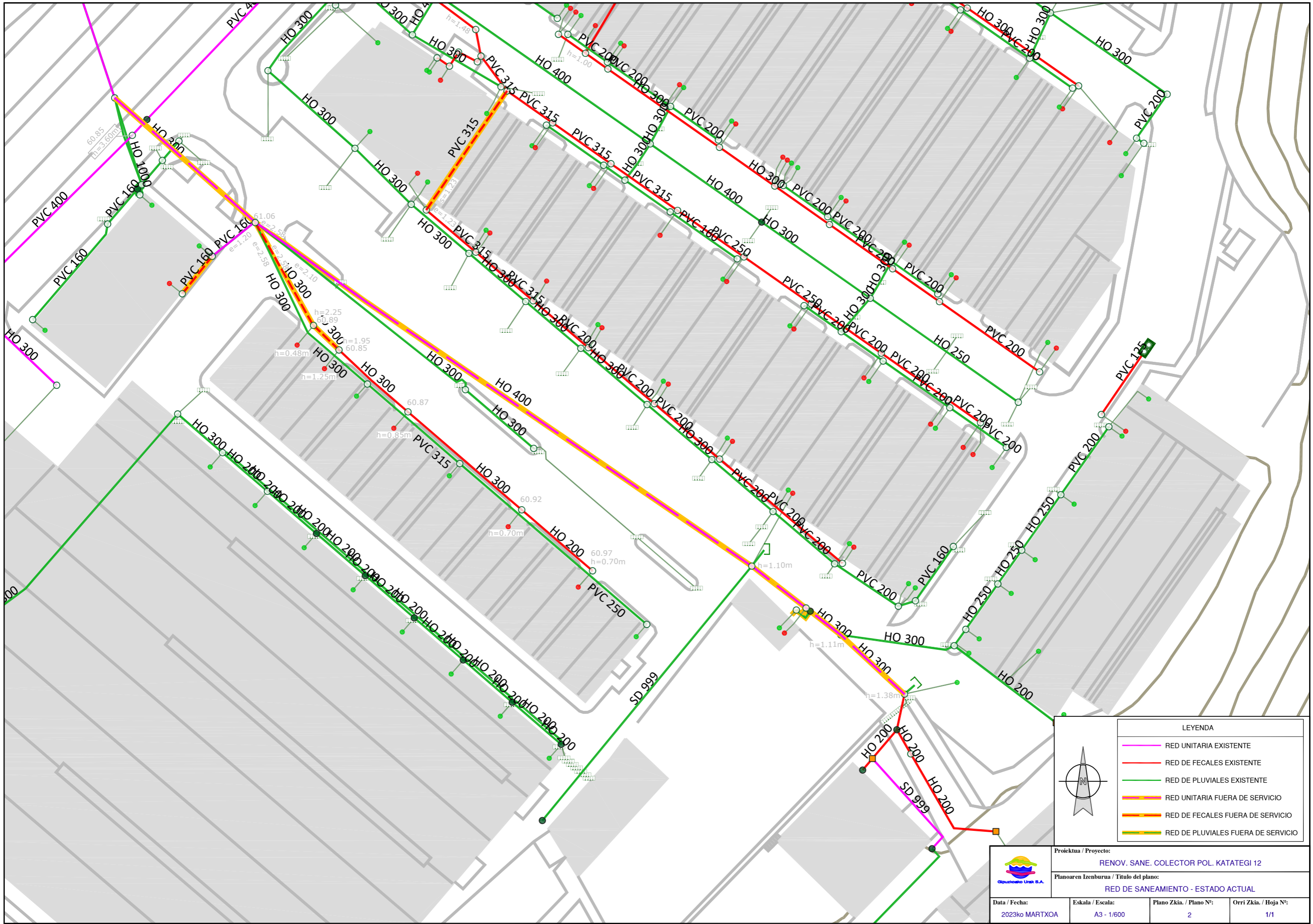

LEYENDA

- RED UNITARIA EXISTENTE
- RED DE FECALES EXISTENTE
- RED DE PLUVIALES EXISTENTE
- RED UNITARIA FUERA DE SERVICIO
- RED DE FECALES FUERA DE SERVICIO
- RED DE PLUVIALES FUERA DE SERVICIO

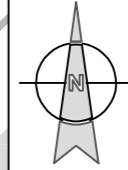

 Gipuzkoako Urak S.A.	Proiektua / Proyecto:		
	REN OV. SANE. COLECTOR POL. KATATEGI 12		
Planoaren Izenburua / Título del plano:			
RED DE SANEAMIENTO - ESTADO ACTUAL			
Data / Fecha:	Eskala / Escala:	Plano Zkia. / Plano Nº:	Orri Zkia. / Hoja Nº:
2023ko MARTXOA	A3 - 1/600	2	1/1

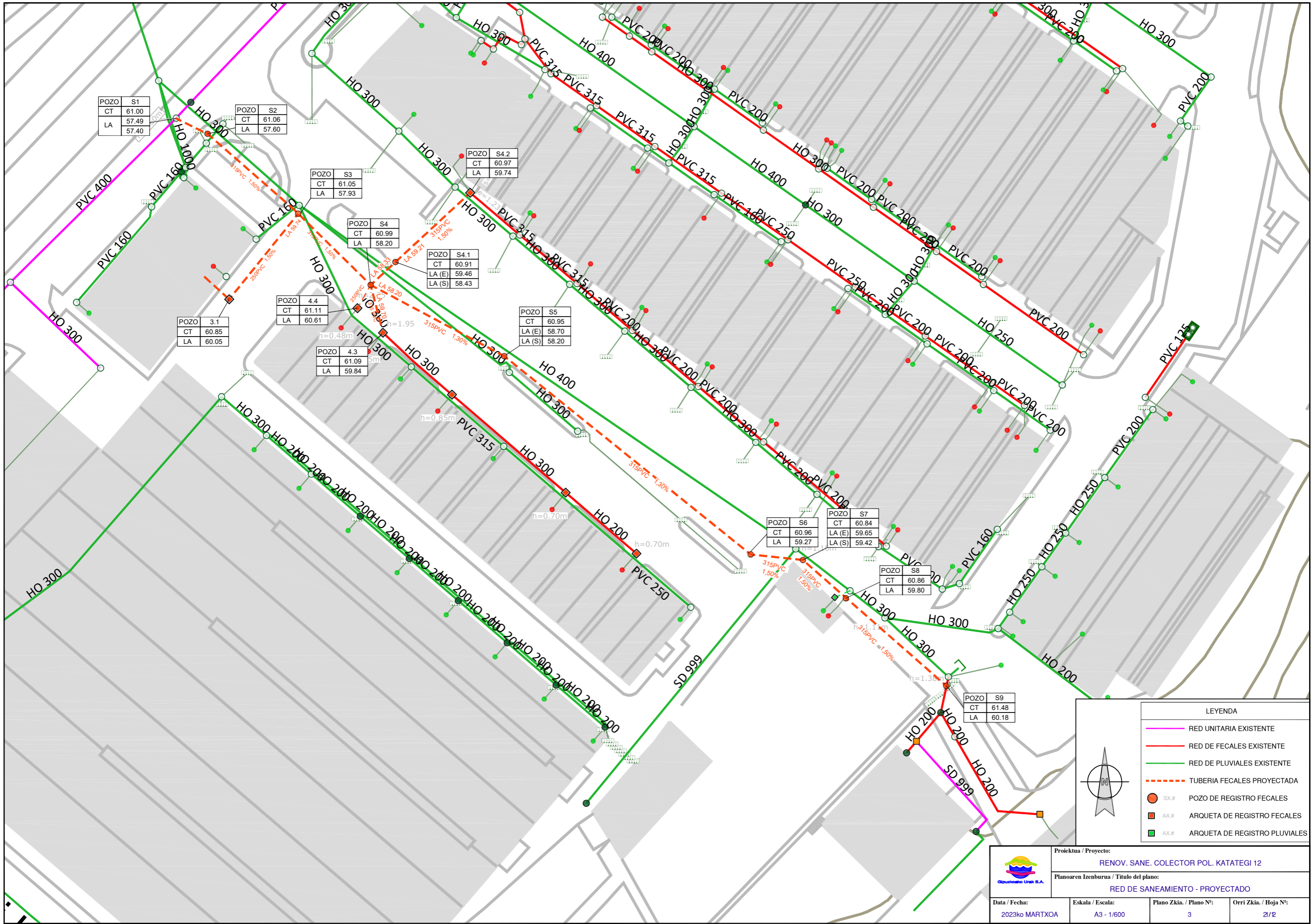

POZO	S1
CT	61.00
LA	57.49
	57.40

POZO	S2
CT	61.06
LA	57.60

POZO	S3
CT	61.05
LA	57.93

POZO	S4.2
CT	60.97
LA	59.74

POZO	S4
CT	60.99
LA	58.20

POZO	S4.1
CT	60.91
LA (E)	59.46
LA (S)	58.43

POZO	3.1
CT	60.85
LA	60.05

POZO	4.4
CT	61.11
LA	60.61

POZO	4.3
CT	61.09
LA	59.84

POZO	S5
CT	60.95
LA (E)	58.70
LA (S)	58.20

POZO	S6
CT	60.96
LA	59.27

POZO	S7
CT	60.84
LA (E)	59.65
LA (S)	59.42

POZO	S8
CT	60.86
LA	59.80

POZO	S9
CT	61.48
LA	60.18

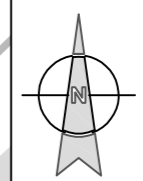

LEYENDA	
	RED UNITARIA EXISTENTE
	RED DE FECALES EXISTENTE
	RED DE PLUVIALES EXISTENTE
	TUBERIA FECALES PROYECTADA
	POZO DE REGISTRO FECALES
	ARQUETA DE REGISTRO FECALES
	ARQUETA DE REGISTRO PLUVIALES

	Proiektua / Proyecto:		
	REN OV. SANE. COLECTOR POL. KATATEGI 12		
	Planoaren Izenburua / Título del plano:		
	RED DE SANEAMIENTO - PROYECTADO		
Data / Fecha:	Eskala / Escala:	Plano Zkia. / Plano Nº:	Orri Zkia. / Hoja Nº:
2023ko MARTXOA	A3 - 1/600	3	21/2

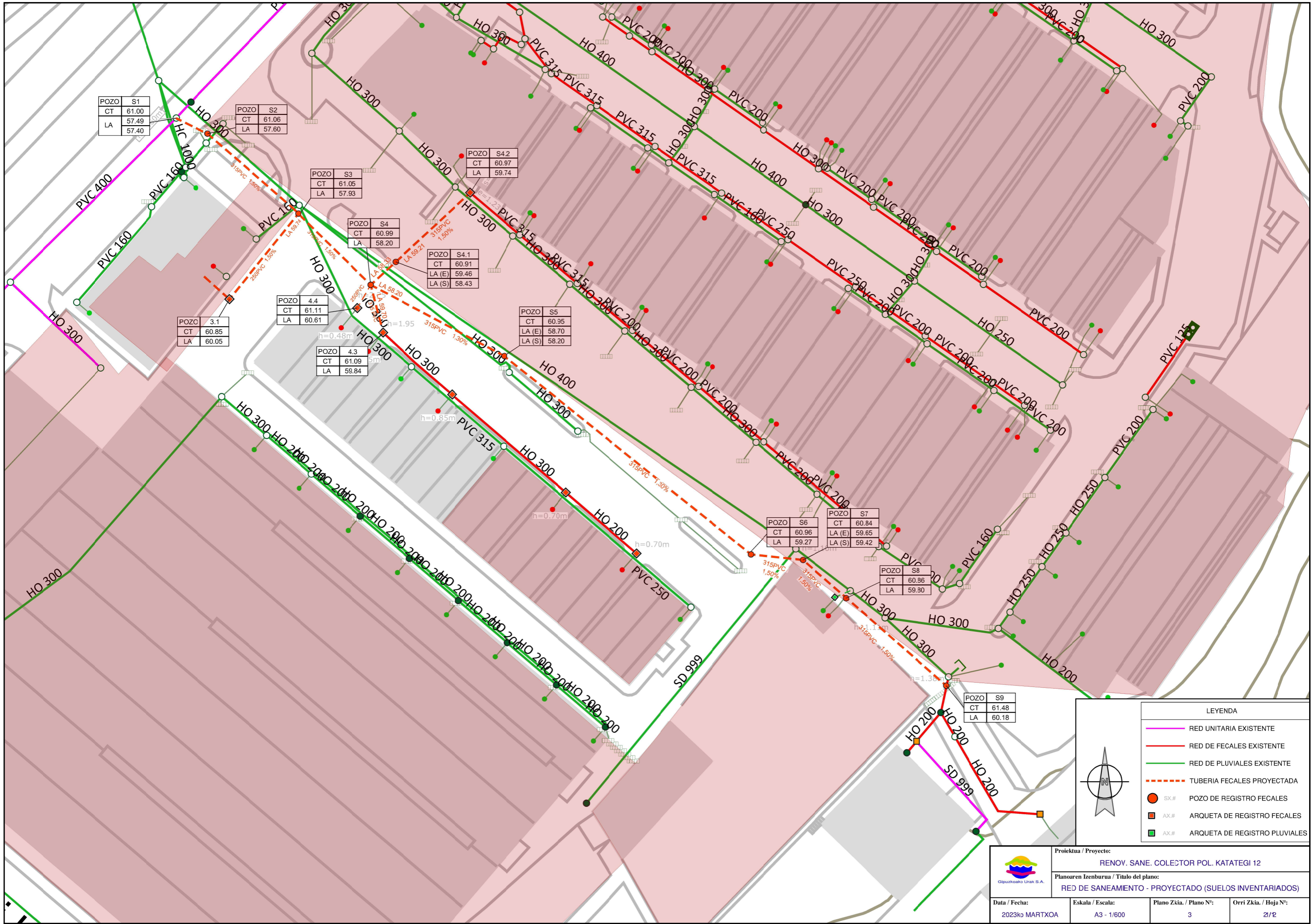

POZO	S1
CT	61.00
LA	57.49
	57.40

POZO	S2
CT	61.06
LA	57.60

POZO	S3
CT	61.05
LA	57.93

POZO	S4.2
CT	60.97
LA	59.74

POZO	S4
CT	60.99
LA	58.20

POZO	S4.1
CT	60.91
LA (E)	59.46
LA (S)	58.43

POZO	S5
CT	60.95
LA (E)	58.70
LA (S)	58.20

POZO	3.1
CT	60.85
LA	60.05

POZO	4.4
CT	61.11
LA	60.61

POZO	4.3
CT	61.09
LA	59.84

POZO	S6
CT	60.96
LA	59.27

POZO	S7
CT	60.84
LA (E)	59.65
LA (S)	59.42

POZO	S8
CT	60.86
LA	59.80

POZO	S9
CT	61.48
LA	60.18

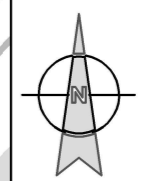

LEYENDA	
	RED UNITARIA EXISTENTE
	RED DE FECALES EXISTENTE
	RED DE PLUVIALES EXISTENTE
	TUBERIA FECALES PROYECTADA
	SX.# POZO DE REGISTRO FECALES
	AX.# ARQUETA DE REGISTRO FECALES
	AX.# ARQUETA DE REGISTRO PLUVIALES

	Proiektua / Proyecto: RENOV. SANE. COLECTOR POL. KATATEGI 12		
	Planoaren Izenburua / Título del plano: RED DE SANEAMIENTO - PROYECTADO (SUELOS INVENTARIADOS)		
Data / Fecha: 2023ko MARTXOA	Eskala / Escala: A3 - 1/600	Plano Zkia. / Plano Nº: 3	Orri Zkia. / Hoja Nº: 21/2

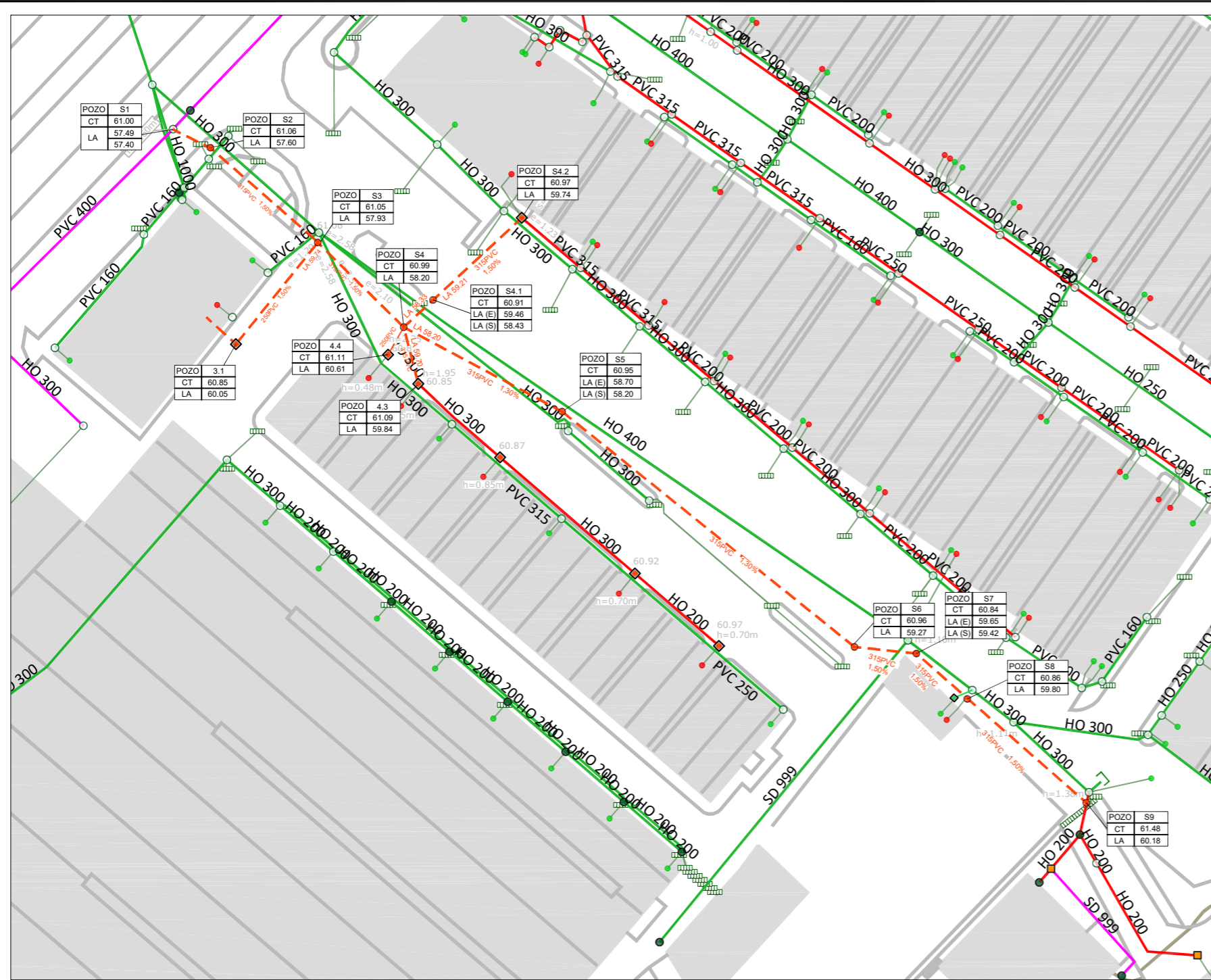

PERFIL LONGITUDINAL - SANEAMIENTO S4

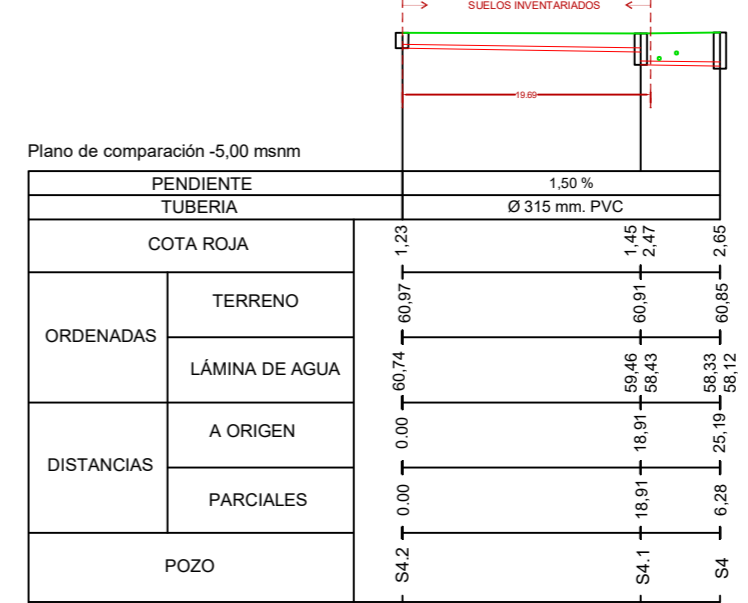

PERFIL LONGITUDINAL - SANEAMIENTO S1 - S9

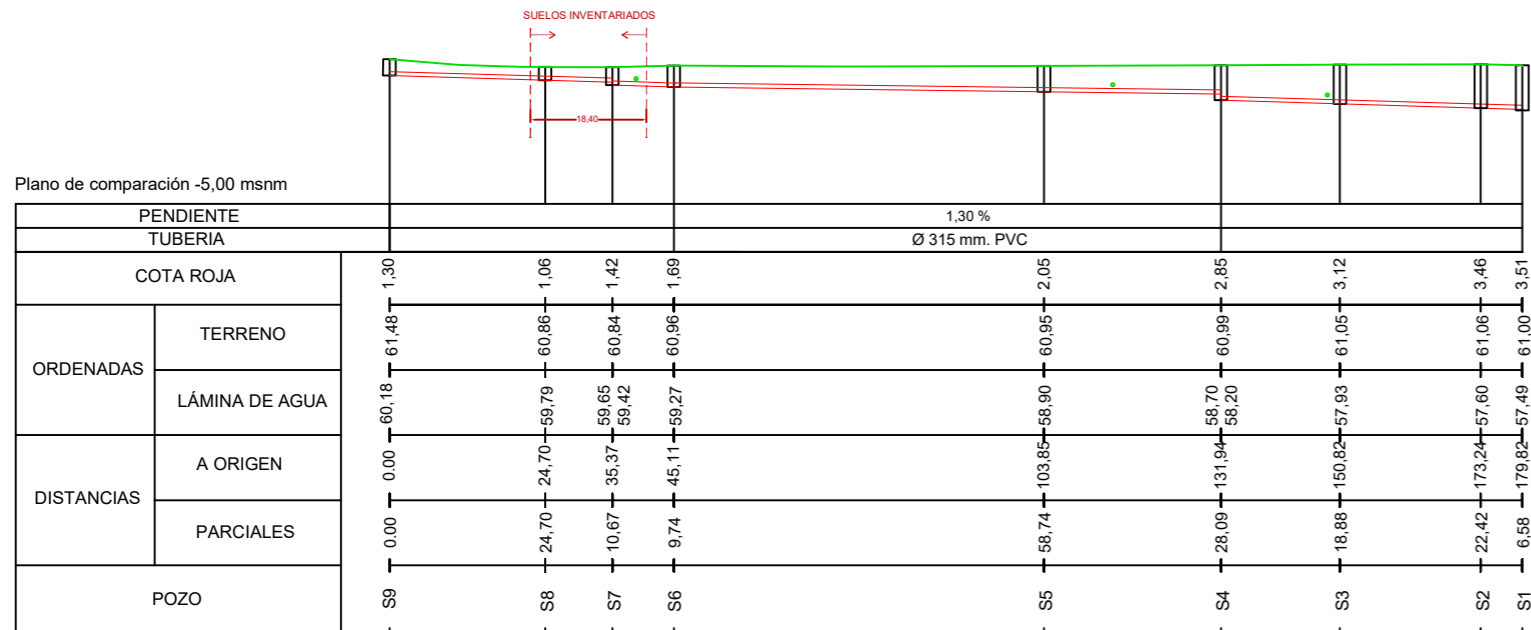

SECCION ZANJA TIPO I
SANEAMIENTO EN ACERA
H > 0.60 m.

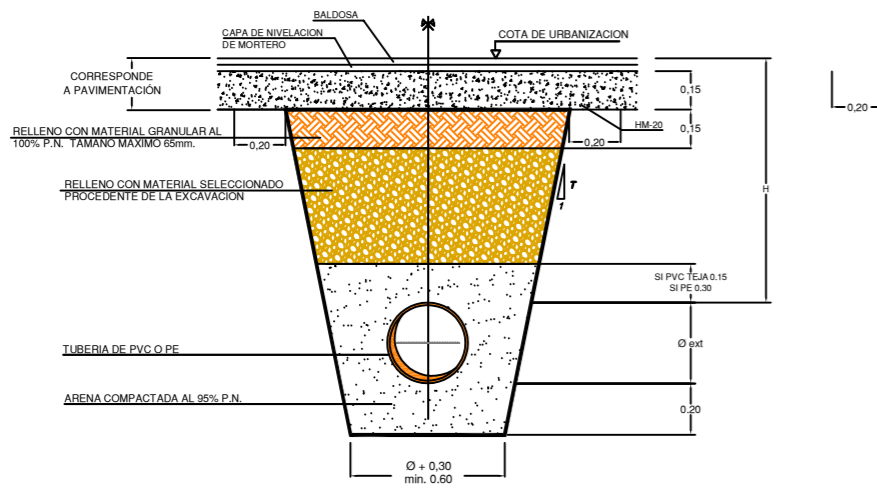

SECCION ZANJA TIPO II
SANEAMIENTO EN CALZADA
H > 0.60 m.

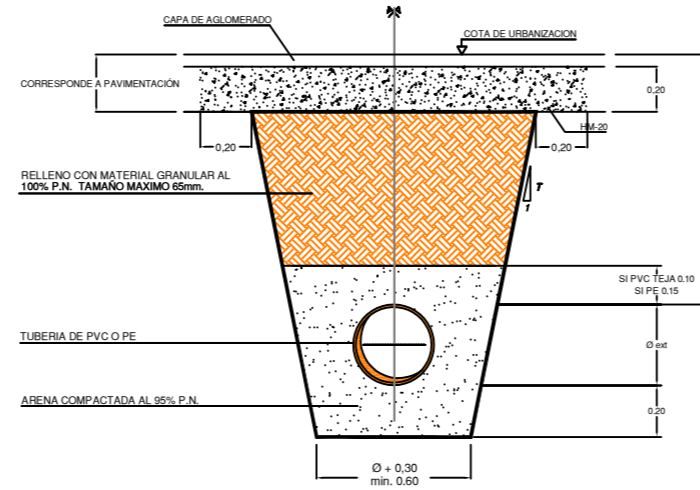

SECCION ZANJA TIPO III
SANEAMIENTO EN TIERRAS
H > 0.60 m.

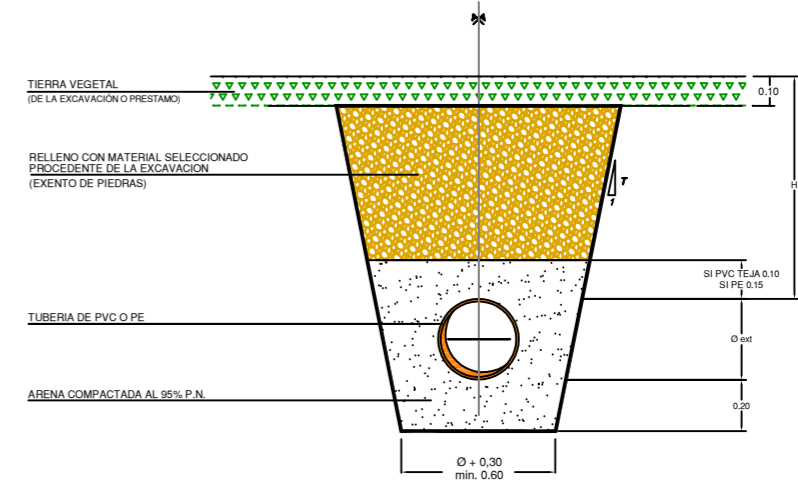

SECCION ZANJA TIPO IV
SANEAMIENTO URBANA
1,25 < H < 2,00 M
315 < Ø < 500

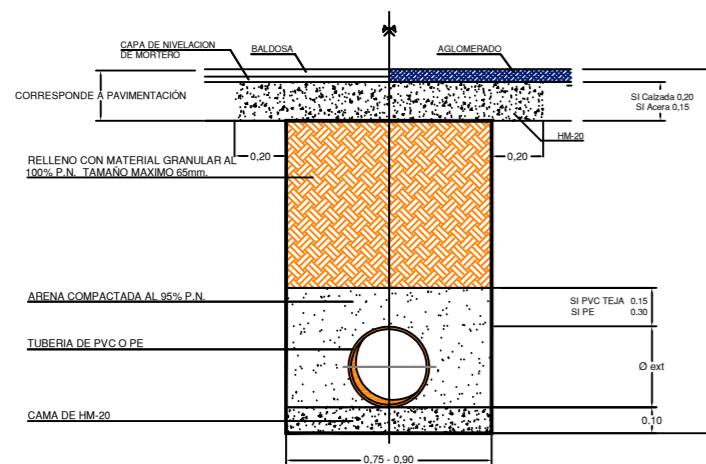

SECCION ZANJA TIPO V
SANEAMIENTO
H < 0.60 M

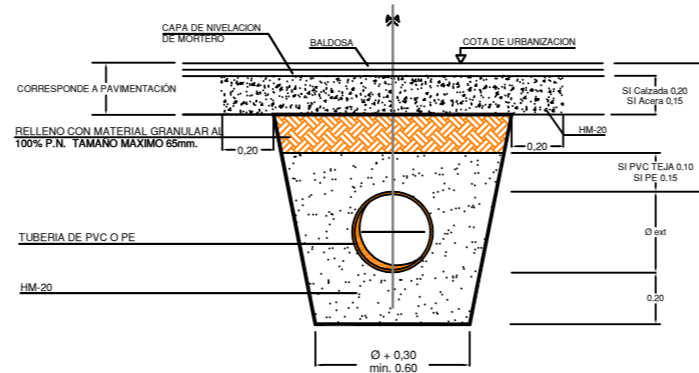

SECCION TIPO ACOMETIDA
SANEAMIENTO

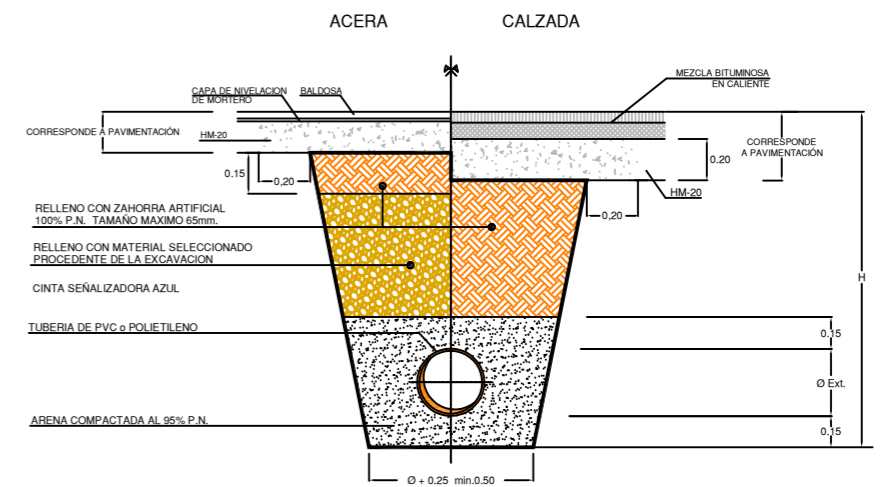

NOTA: H > 0.85m. PARA TUBERIAS Ø > 100mm.
H > 0.65m. PARA TUBERIAS Ø < 100mm.

	Proiektua / Proyecto:		
	REN OV. SANE. COLECTOR POL. KATATEGI 12		
Planoaren Izenburua / Título del plano:			
ZANJAS TIPO SANEAMIENTO			
Data / Fecha:	Eskala / Escala:	Plano Zkia. / Plano Nº:	Orri Zkia. / Hoja Nº:
2023ko MARTXOA	- / -	5	1 / 2

SECCION ZANJA TIPO
SANEAMIENTO IV ARENA
1,50 < H < 2,00 m.

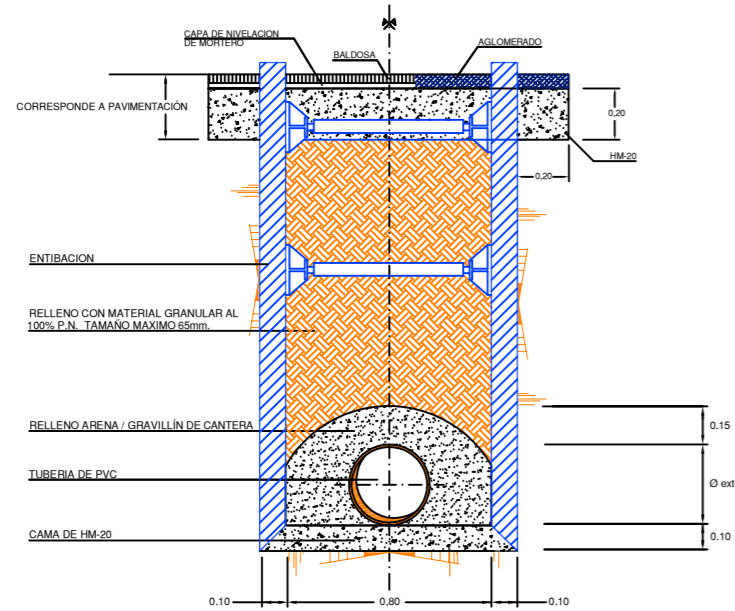

SECCION ZANJA TIPO
SANEAMIENTO VI HGON.
1,50 < H < 2,00 m.

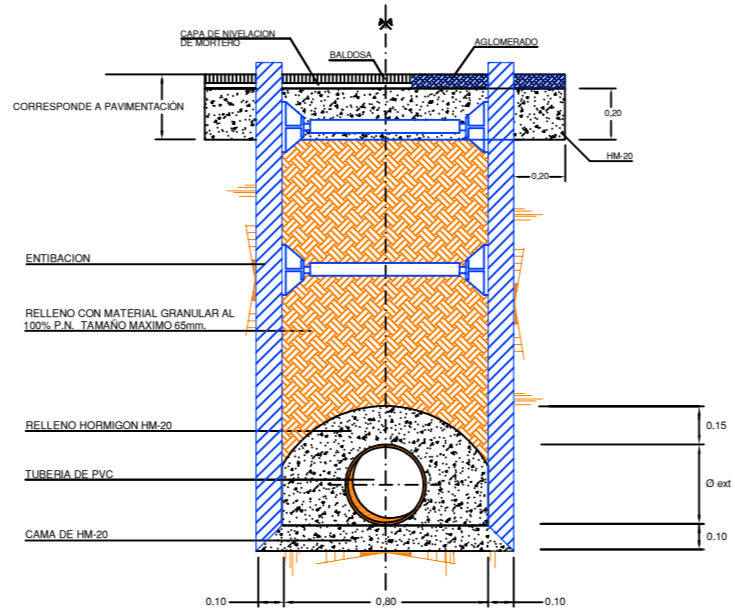

SECCION ZANJA TIPO
SANEAMIENTO VIII
3,00 < H < 4,00 m.

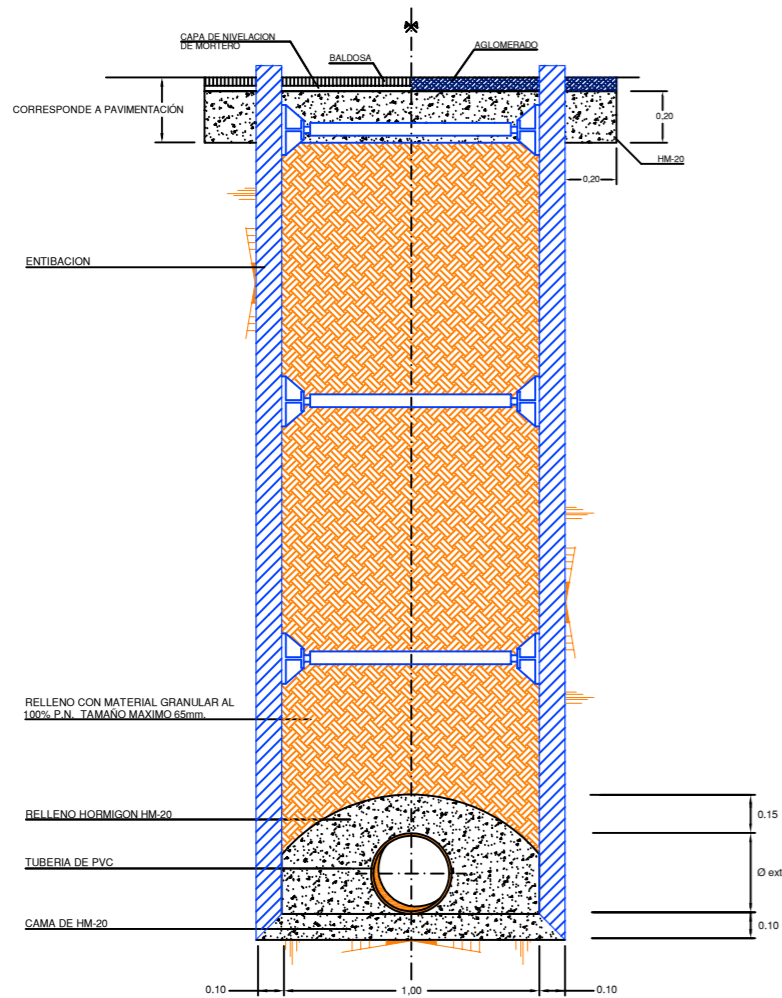

SECCION ZANJA TIPO
SANEAMIENTO VII
2,00 < H < 3,00 m.

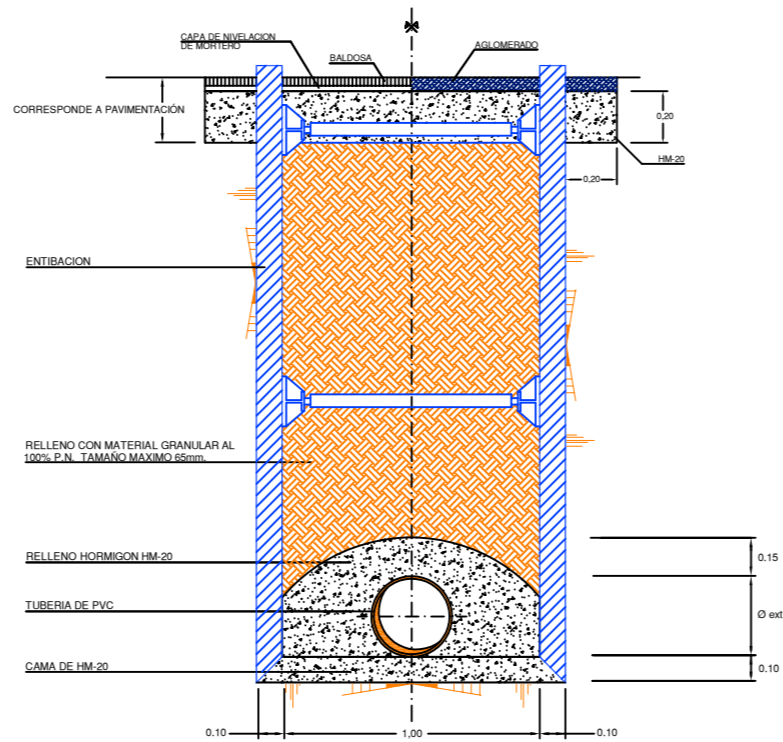

	Proiektua / Proyecto:		
	REN OV. SANE. COLECTOR POL. KATATEGI 12		
Planoaren Izenburua / Título del plano:			
ZANJAS TIPO SANEAMIENTO			
Data / Fecha:	Eskala / Escala:	Plano Zkia. / Plano Nº:	Orri Zkia. / Hoja Nº:
2023ko MARTXOA	- / -	5	2 / 2

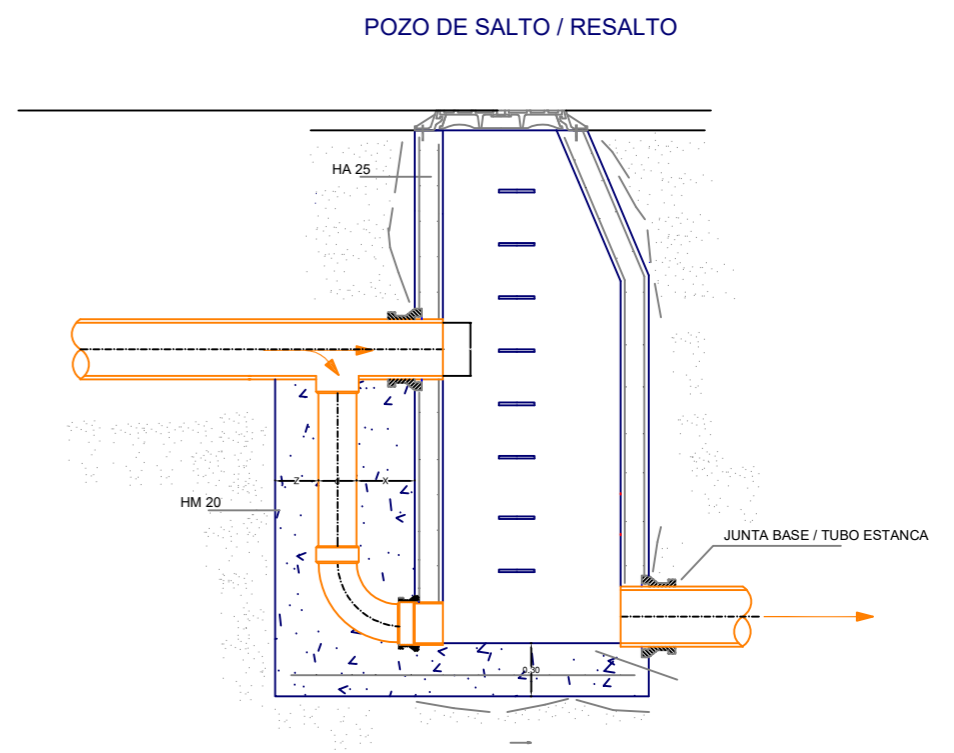
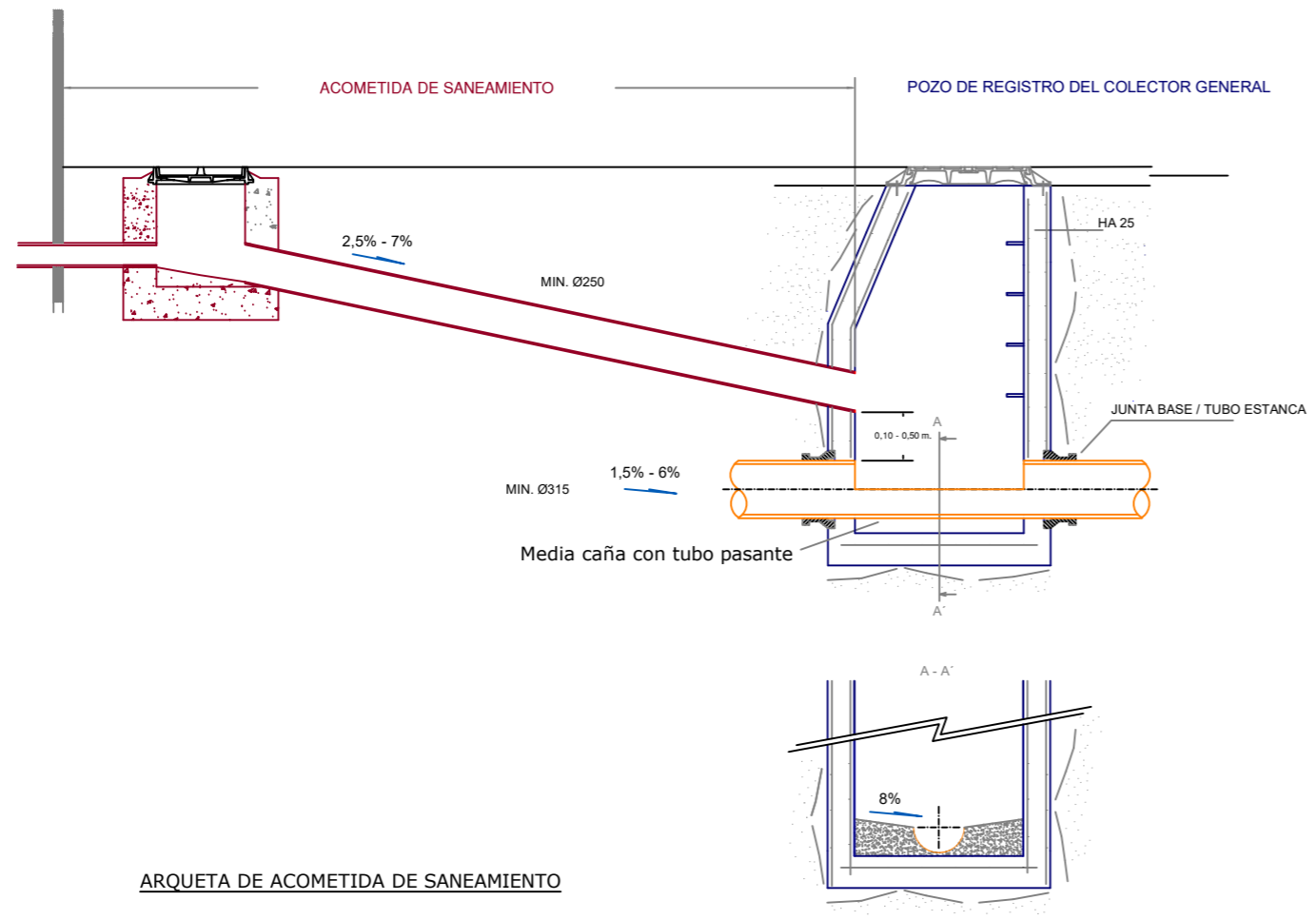

ARQUETA DE ACOMETIDA DE SANEAMIENTO

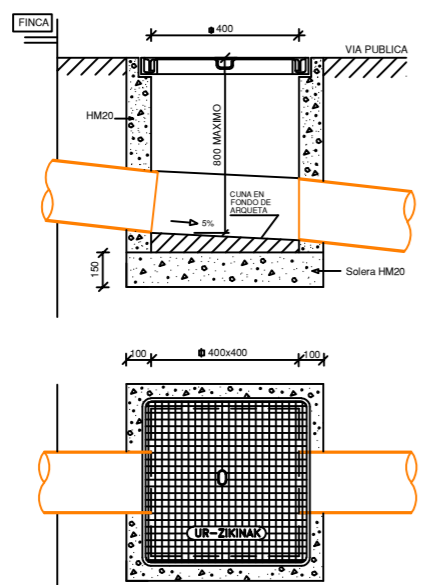

DETALLE COLOCACIÓN MARCO Y TAPA

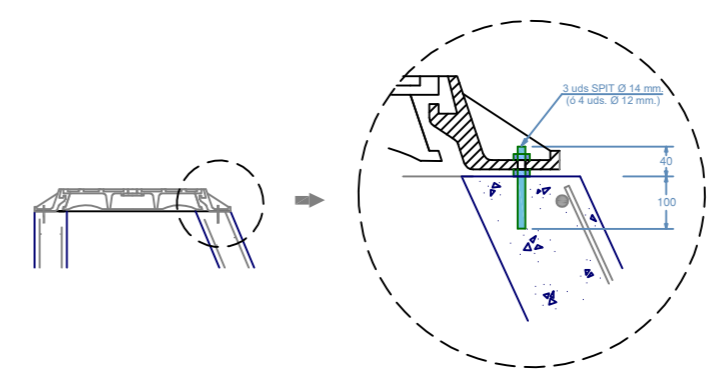

	Proiektua / Proyecto:			
	REN OV. SANE. COLECTOR POL. KATATEGI 12			
Planoaren Izenburua / Título del plano:				
DETALLES SANEAMIENTO				
Data / Fecha:	Eskala / Escala:	Plano Zkia. / Plano Nº:	Orri Zkia. / Hoja Nº:	
2023ko MARTXOA	- / -	6	1 / 1	