



GIPUZKOAKO UR KONTSORTZIOA

BLANCA VINUESA ERAIKINA
PORTUETXE 16, 1.SOILAIRUA
C.P: 20018 DONOSTIA - GIPUZKOA

TEL. 943 319500
FAX. 943 697050

Nombre de proyecto : DEP AIA BBO HILERRI Rev04

Sistema : ARRI_TELE

Fabricante electrico :

Numeracion de Referencia :

Responsable del proyecto :

Instalacion : AIA AUZOA 17-1, Bajo-1. ATAUN

CUPS : ES 0021 0000 0314 3020 BK

Creado : 08/12/2015

Modificado : 15/06/2019

Número de páginas maximas : 9

Cantidad de páginas : 9

			Fecha	Nombre	Numero		Cliente:	Proyecto/ N° Pedido:		
			Diseñado			 <p>Gipuzkoako Ur Kantsortzioa Gipuzkoako Urak</p>	GIPUZKOAKO UR KONTSORTZIOA	DEP AIA BBO HILERRI Rev04		
			Comprob.	08/12/2015			Denomin.	Hoja de titulo		
			Ult.Modif.	15/06/2019			DEP AIA BBO HILERRI Rev04	De pagina	Pagina n°	A pagina
			Ploteado					0	1	1

Indice de páginas

Columna X: una página creada automáticamente se ha modificado de forma manual

F06_001

Página	Descripción de página	Campo adicional de página	Fecha	Responsable	X
=CA1+AAA/0	Hoja de título		03/04/2019	CCV	X
=CA1+AAA/1	INFORME DE MODIFICACIONES		08/06/2019	CCV	X
=CA1+AAA/2	INDICE DE PAGINAS		08/06/2019	CCV	
=CA1+AAA/3	CAJA DE DISTRIBUCIOIN		08/06/2019	CCV	
=CA1+AAA/4	UNIFILAR		08/06/2019	CCV	
=CA1+AAA/5	ESQUEMA BBO AIA HILERRI 1		08/06/2019	CCV	
=CA1+AAA/6	ESQUEMA BBO AIA HILERRI 2		08/06/2019	CCV	
=CA1+AAA/7	ESQUEMA BBO AIA HILERRI 3		08/06/2019	CCV	
=CA1+AAA/8	ESQUEMA BBO AIA HILERRI 4		08/06/2019	CCV	

DEPOSITO AIA

DEPOSITO

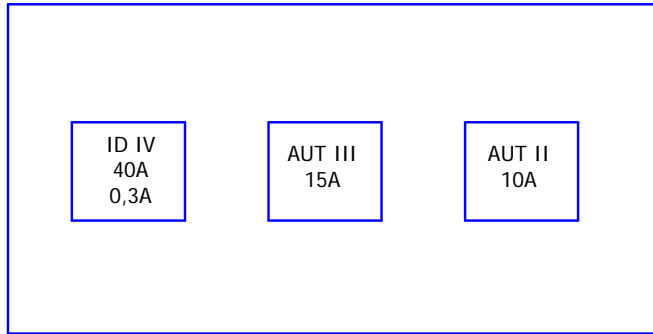

CLORACION

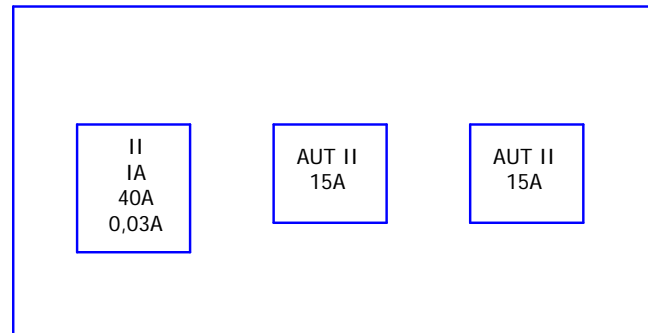

	Fecha	Nombre	Numero
Diseñado			
Comprob.	08/12/2015		
Ult.Modif.	15/06/2019		
Ploteado			



Cliente: GIPUZKOAKO UR KONTSORTZIOA

Denomin.:
DEP AIA BBO HILERRI Rev04

Proyecto/ N° Pedido:
DEP AIA BBO HILERRI Rev04

CAJA DE DISTRIBUCIOIN

De pagina 2	Pagina n° 3	A pagina 4
----------------	----------------	---------------

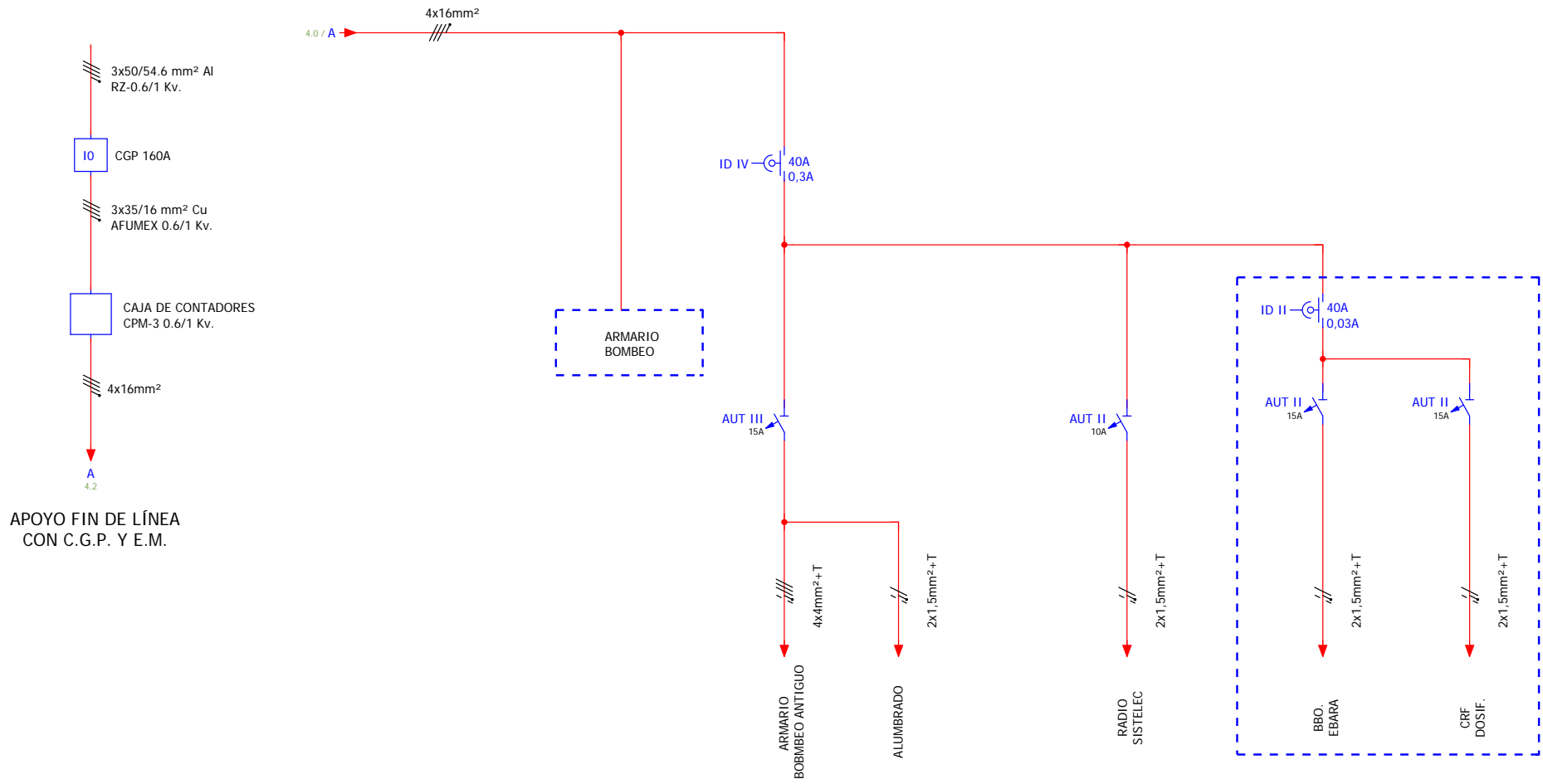

Fecha	Nombre	Numero
Diseñado		
Comprob.	08/12/2015	
Ult.Modif.	15/06/2019	
Ploteado		



Cliente:	GIPUZKOAKO UR KONTSORTZIOA
Denomin.	DEP AIA BBO HILERRI Rev04

Proyecto/ N° Pedido: DEP AIA BBO HILERRI Rev04		
UNIFILAR		
De pagina 3	Pagina n° 4	A pagina 5

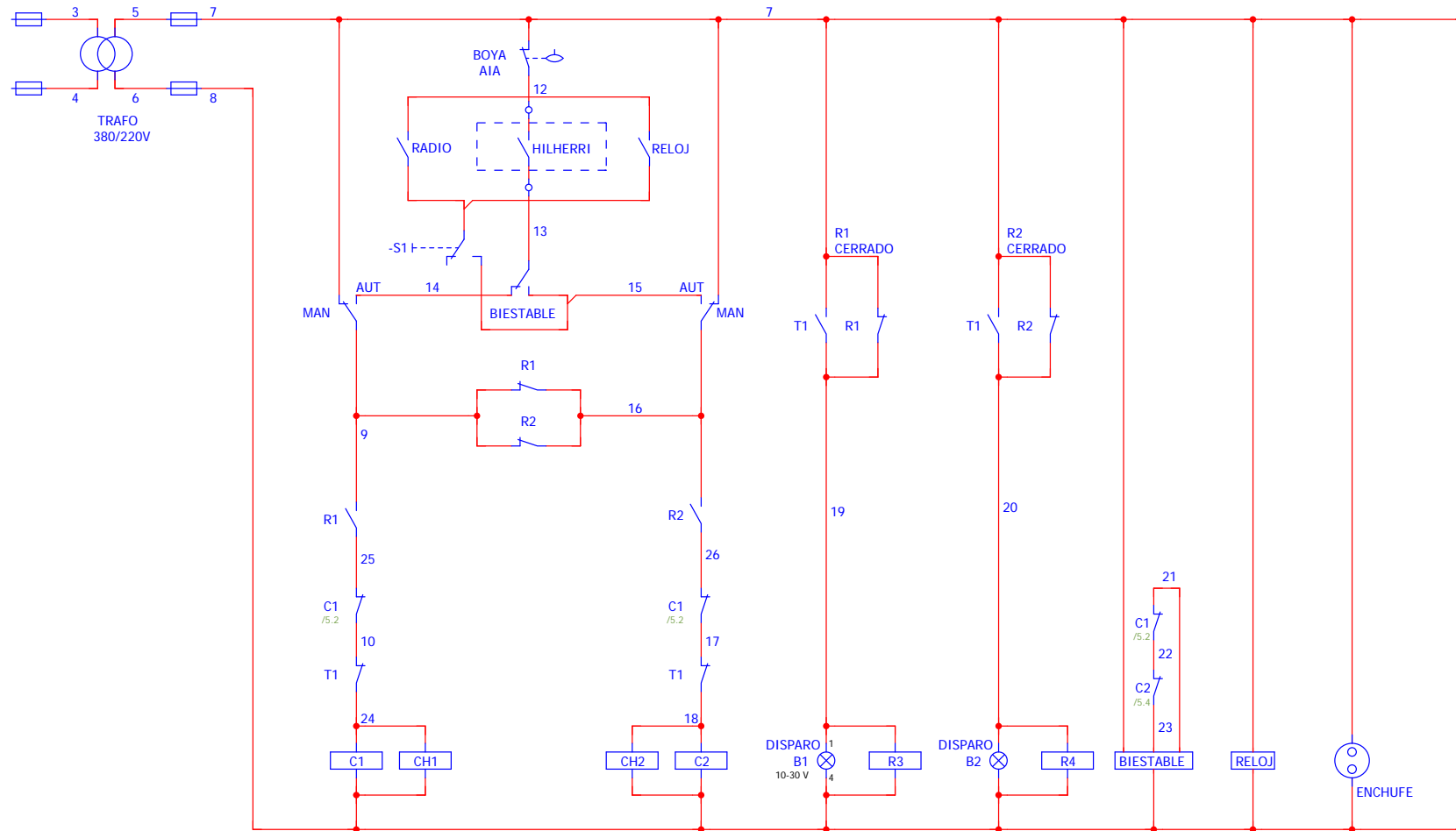

	Fecha	Nombre	Numero
Diseñado			
Comprob.	08/12/2015		
Ult.Modif.	15/06/2019		
Ploteado			



Cliente: GIPUZKOAKO UR KONTSORTZIOA

Denomin.: DEP AIA BBO HILERRI Rev04

Proyecto/ N° Pedido:
DEP AIA BBO HILERRI Rev04
ESQUEMA BBO AIA HILERRI 1

De pagina	Pagina nº	A pagina
4	5	6

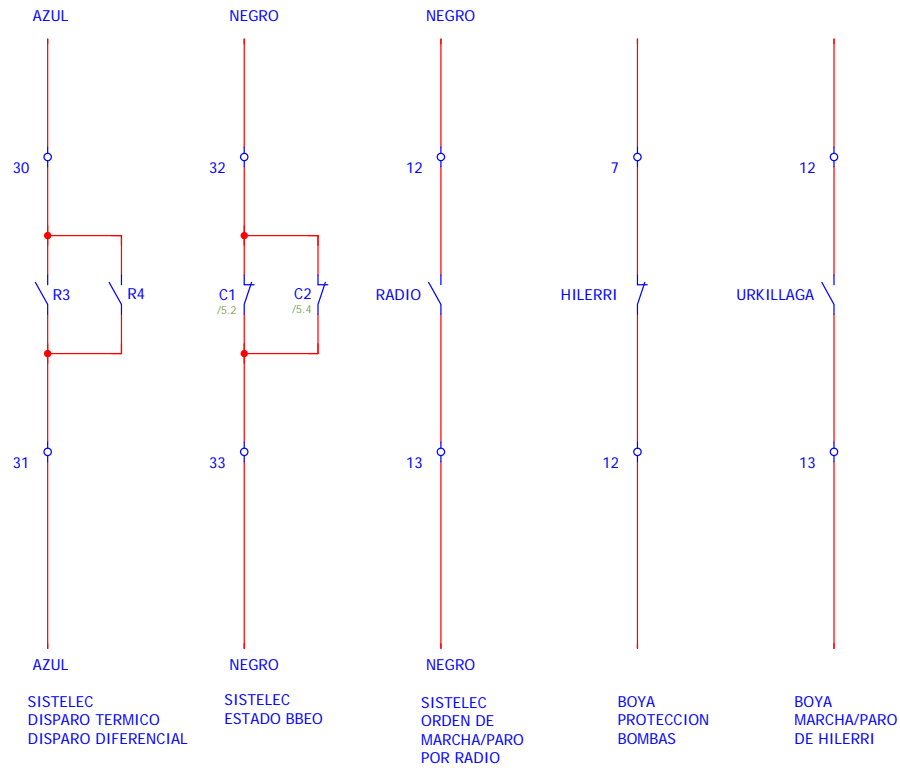

	Fecha	Nombre	Numero
Diseñado			
Comprob.	08/12/2015		
Ult.Modif.	15/06/2019		
Ploteado			



Cliente: GIPUZKOAKO UR KONTSORTZIOA

Denomin.
DEP AIA BBO HILERRI Rev04

Proyecto/ N° Pedido:
DEP AIA BBO HILERRI Rev04
ESQUEMA BBO AIA HILERRI 2

De pagina 5	Pagina n° 6	A pagina 7
----------------	----------------	---------------

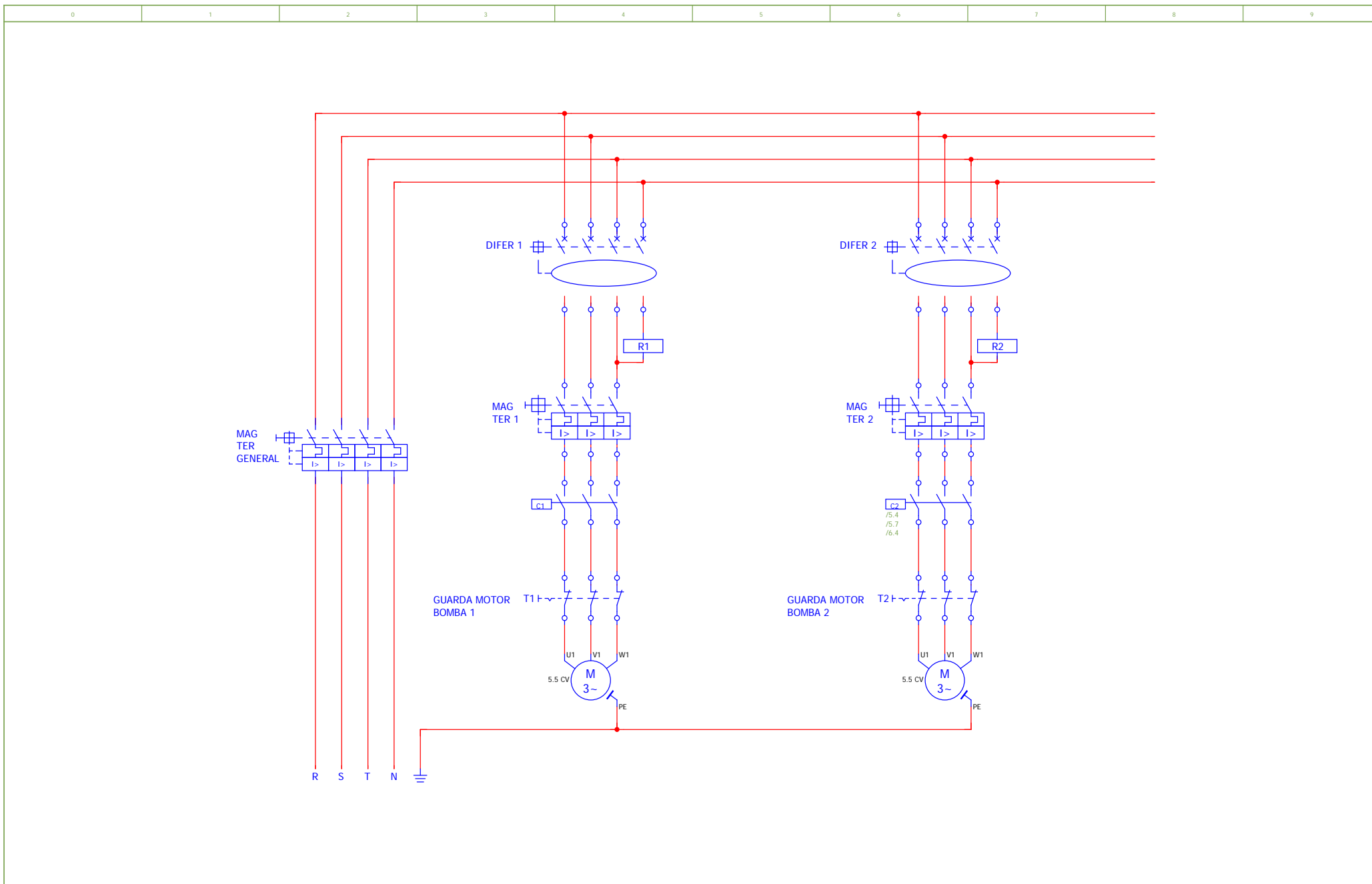

	Fecha	Nombre	Numero
Diseñado			
Comprob.	08/12/2015		
Ult.Modif.	15/06/2019		
Ploteado			



Ciente:	GIPUZKOAKO UR KONTSORTZIOA		
Denomin.	DEP AIA BBO HILERRI Rev04		
	ESQUEMA BBO AIA HILERRI 3		
	De pagina	Pagina nº	A pagina
	6	7	8

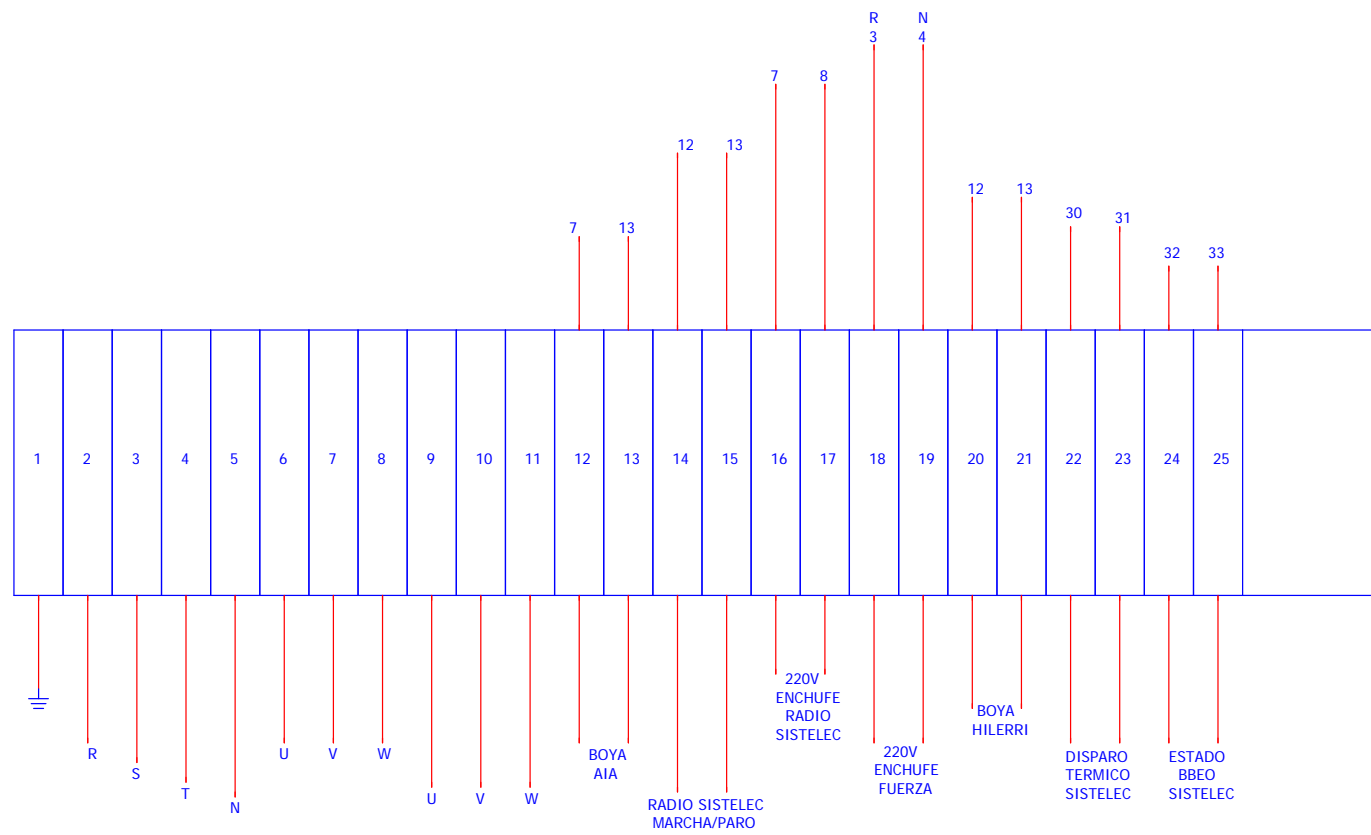

	Fecha	Nombre	Numero
Diseñado			
Comprob.	08/12/2015		
Ult.Modif.	15/06/2019		
Ploteado			



Ciente:	GIPUZKOAKO UR KONTSORTZIOA
Denomin.	DEP AIA BBO HILERRI Rev04

Proyecto/ N° Pedido:		
DEP AIA BBO HILERRI Rev04		
ESQUEMA BBO AIA HILERRI 4		
De pagina	Pagina n°	A pagina
7	8	